



FACTORY TUNED ENGINE

O.S. SPEED 21XZ-M

INSTRUCTION MANUAL

It is of vital importance, before attempting to operate your engine, to read the general 'SAFETY INSTRUCTIONS AND WARNINGS' in the following section and to strictly adhere to the advice contained therein.

• Also, please study the entire contents of this instruction manual, so as to familiarize yourself with the controls and other features of the engine.

SAFETY INSTRUCTIONS AND WARNINGS ABOUT YOUR O.S. ENGINE

Remember that your engine is not a "toy", but a highly efficient internal-combustion machine whose power is capable of harming you, or others, if it is misused or abused. As owner, you, alone, are responsible for the safe operation of your engine, so act with discretion and care at all times. If at some future date, your O.S. engine is acquired by another person, we would respectfully request that these instructions are also passed on to its new owner.

■ The advice which follows is grouped under two headings according to the degree of damage or danger which might arise through misuse or neglect.

⚠ WARNINGS

These cover events which might involve serious (in extreme circumstances, even fatal) injury.

⚠ NOTES

These cover the many other possibilities, generally less obvious sources of danger, but which, under certain circumstances, may also cause damage or injury.

⚠ WARNINGS

Never touch, or allow any object to come into contact with, the rotating propeller and do not crouch over the engine when it is running.

Model engine fuel is poisonous. Do not allow it to come into contact with the eyes or mouth. Always store it in a clearly marked container and out of the reach of children.

Model engine fuel is also highly flammable. Keep it away from open flame, excessive heat, sources of sparks, or anything else which might ignite it. Do not smoke or allow anyone else to smoke, near to it.

Model engines generate considerable heat. Do not touch any part of your engine until it has cooled. Contact with the muffler (silencer), cylinder head or exhaust header pipe, in particular, may result in a serious burn.

Never operate your engine in an enclosed space. Model engines, like automobile engines, exhaust deadly carbon-monoxide. Run your engine only in an open area.

⚠ NOTES

- This engine was designed for model boats. Do not attempt to use it for any other purpose.
- Mount the engine in your model securely, following the manufacturers' recommendations, using appropriate screws and locknuts.

• Install an effective silencer (muffler). Frequent close exposure to a noisy exhaust (especially in the case of the most powerful high-speed engines) may eventually impair your hearing and such noise is also likely to cause annoyance to others over a wide area.

• For their safety, keep all onlookers (especially small children) well back (at least 20 feet or 6 meters) when preparing your model for running.

• Take care that the glowplug clip or battery leads do not come into contact with the propeller or any other rotating parts. Also check that the linkage to the throttle arm is secure.

• If your engine does not have a built-in recoil starter, use an electric starter. The wearing of safety glasses is also strongly recommended.

• When handling the boat immediately prior to launching, be especially cautious. Keep the propeller and other rotating parts away from you.

• Before starting the engine, always check the tightness of all the screws and nuts especially those of joint and movable parts such as throttle arm. Missing retightening the loose screws and nuts often causes the parts breakage that is capable of harming you.

• Adjust the throttle linkage so that the engine stops when the throttle stick and trim lever on the transmitter are fully retarded. Alternatively, the engine may be stopped by cutting off the fuel supply. Never try to stop the engine physically.

• Warning! Immediately after a glowplug-ignition engine has been run and is still warm, conditions sometimes exist whereby it is just possible for the engine to abruptly restart if it is rotated over compression WITHOUT the glowplug battery being reconnected.

ENGINE CONSTRUCTION

With this engine, the piston will feel tight at the top of its stroke (TDC) when the engine is cold. This is normal. The cylinder bore has a slight taper. The piston and cylinder are designed to achieve a perfect running clearance when they reach operating temperature.

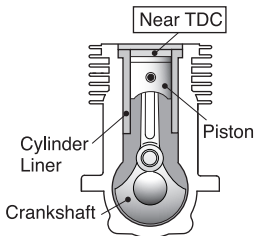

Slight taper

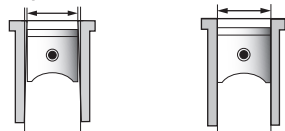

When the engine is cold. When the engine is hot.

NOTES WHEN APPLYING AN ELECTRIC STARTER

Do not over-prime. This could cause a hydraulic lock and damage the engine on application of the electric starter. If over-primed, remove glowplug, close needle-valve and apply starter to pump out surplus fuel. Cover the head with a rag to prevent any pumped out fuel from getting into your eyes.

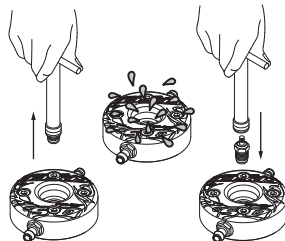

NOTES ON OPERATION

ABOUT THE WARRANTY

Since this is a special SPEED version, individual special parts are available only for limited period (one year after finishing the production). Also, the engine is free of warranty due to damage and/or wear occurred during running.

NOTE

We do not recommend running your boat on the sea, or in any other saltwater environment. Under such conditions, it is difficult to prevent the engine from becoming corroded and, eventually, inoperative.

NOTE

As delivered, the engine has the carburetor lightly fit into its intake. Secure it changing its angle according to the hull.

ABOUT THE ENGINE

The O.S. SPEED 21XZ-M is a high performance engine designed expressly for 21 class boat Racing. Based on the MAX-21XZ-M, major parts have been refined to have a powerful potential equal to more expensive specially tuned or modified engines.

Standard accessories

- Glow Plug RP7 For T-type head (Turbo head) 1piece
- Cylinder-head gasket (0.2mm) 1 sheet
- Exhaust Seal Ring 1piece
- Dust Cap 3mm, 16mm, 18mm 1piece each

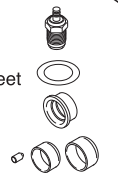

TOOLS, ACCESSORIES, etc.

The following items are necessary for operating the engine.

- Items necessary for starting

FUEL

Generally, it is suggested that the user selects a fuel that is commercially available for model two-stroke engines and contains 10-30% nitromethane. As a starting point, we recommend a fuel containing 20% nitromethane, changing to a fuel containing more nitro if necessary. When the brand of fuel is changed, or the nitro content increased, it is advisable to repeat the running-in procedure referred to in the RUNNING-IN paragraphs. Please note that with high-nitro fuels, although power may be increased for competition purposes, glowplug elements do not last as long and engine life will be shortened.

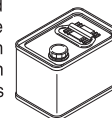

PROPELLER

Use well balanced propellers only. As the ideal diameter, pitch and shape vary according to the size, weight and type of model, final selection can be made after practical experiment. As a starting point, suggested propeller diameter is 41-43mm with a pitch/dia ratio of 1.0-1.1 for in-drive Vee type hulls, 40-45mm with a pitch/dia. ratio of 1.2-1.6 for out-drive Vee type hulls and 44-46mm with a pitch/dia. ratio of 1.4-1.6 for hydroplanes.



NOTE Never use a propeller that has even slight damage.

GLOWPLUG IGNITER

Commercially available handy glowplug heater in which the glowplug battery and battery leads are integrated.

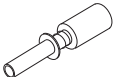

STARTER BELT

Necessary for starting the engine. It is suggested to keep a starter rope as a reserve.



ELECTRIC STARTER AND STARTER BATTERY

Use a 12-volt electric starter with suitable battery for starting the engine.

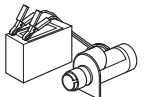

SUPER FILTER (L) (Option)

Install a filter to the outlet tube of your refuelling container to prevent entry of foreign matter into the fuel tank.



SILICONE TUBING

This is required for the connection between the fuel tank and engine, also for the water cooling system. Inner dia. of 2.3-2.5mm and outer dia. of 5-5.5mm would be suitable.



TOOLS

O.S. SPEED DRIVER TOOLS

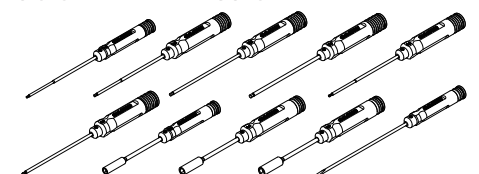

O.S. SPEED PLUG WRENCH

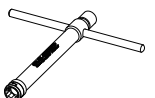

ENGINE PARTS NAME

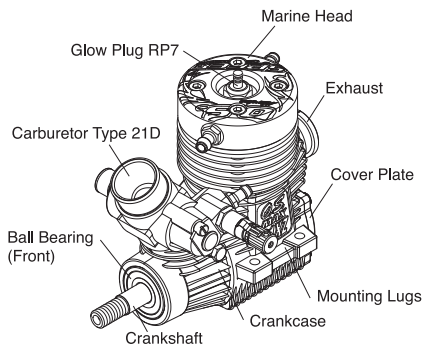

CARBURETOR CONTROLS

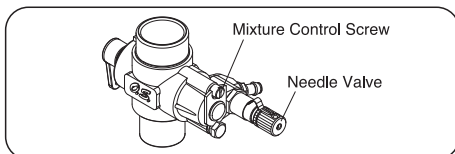

Two adjustable controls are provided on this carburetor.

The Needle-Valve:

For adjusting the mixture strength when the throttle is fully open.

The Mixture Control Screw:

For adjusting the mixture strength at part-throttle and idle speed, to obtain steady idling and smooth acceleration to mid speeds.

BASIC POSITION OF MIXTURE CONTROL SCREW (Mixture Control Valve)

As delivered, the Mixture Control screw is positioned at approximately the center as shown in the sketch. (In case of 30% nitro fuel) Mixture gets lean when the Mixture Control Screw is turned right, while mixture gets rich when the Mixture Control Screw is turned left. With a model boat, adjustments vary with combined various factors such as climatic conditions, fuel, muffler, etc. Therefore, Mixture Control Screw position varies with each model and set-up, and it is normal if the Mixture Control Screw position is off center.

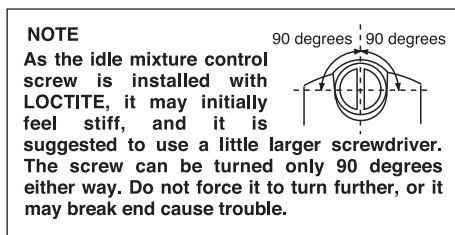
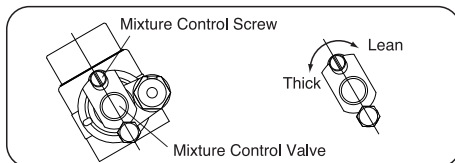

INSTALLATION OF THE STANDARD ACCESSORIES

Installing the glow plug. Insert RP7 plug supplied into marine head carefully, making sure that it is not cross-threaded before tightening firmly. (All the O.S. T-Type plugs including the RP7 are not supplied with a washer.)

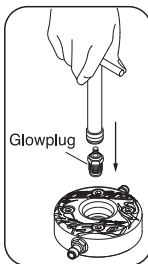

Install the exhaust seal ring supplied.

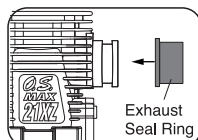

INSTALLATION OF THE DUST CAP SET

If the engine is to be stored or out of use for a while, install the included exhaust and carburetor dust caps to prevent foreign matter from entering the engine.

INSTALLATION OF THE CARBURETOR

As delivered, the engine has its carburetor lightly installed in the intake boss. Secure it as follows.

1. Loosen the retainer screw, rotate the carburetor to its correct position and make sure that it is pressed well down into the intake boss, compressing the rubber gasket, before retightening screw.
2. Rotate the retainer screw gently until it stops, then tighten a further 120-180°. Do not overtighten the screw as this will damage the carburetor spacer.

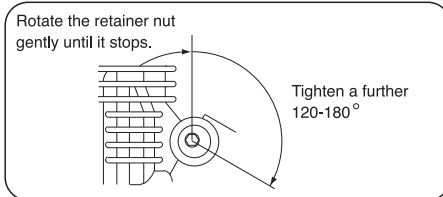

Note

Be careful not to damage the O rings when removing the carburetor retainer from the engine. First, remove the retainer Retaining screw, then pull out each part. Do not push the part in or damage the O rings.

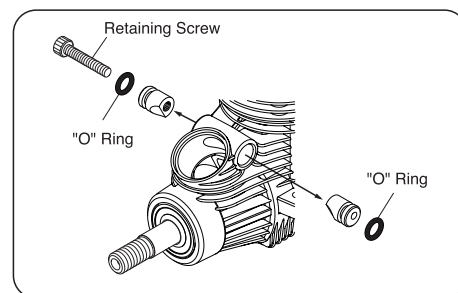

ENGINE INSTALLATION

Before installing the engine in the model, clean out the engine compartment. If any remaining sand paper and glass wool residues are not removed completely, they may be sucked into the engine and damage the engine.

1. Make sure that the engine mounting beams in the hull are parallel, with their top surfaces in the same plane. If they are not, the engine will not rest firmly as the engine mounting faces (undersides of the mounting lugs) are precision machined to be flat and in the same plane. Poor installation may not only cause vibration, erratic running and loss of performance, but may also damage the engine itself by deforming the crankcase, cylinder, etc.
2. The mounting beams and adjacent hull structure should be as rigid as possible so that the engine may develop its full performance. Use 3mm steel screws, such as Allen socket-head type, with locknuts, for bolting the engine to the mounting beams.

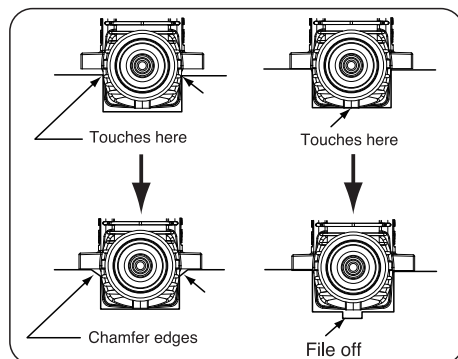

3. If the holes in the mounting beams do not align exactly with the engine's mounting lugs, enlarge them slightly with a needle file so that the mounting screws pass through the holes smoothly without being forced.
4. Screws are prone to loosen during running. Be sure to use the Lock Washers available as optional extra or locking glue to prevent their loosening.

RUNNING-IN ('Breaking-in')

Running-in is a procedure for an engine to come close to actual running conditions (fuel, r.p.m., engine temperature, etc.).

Excessively rich running and prolonged low speed running should be avoided. Prolonged low speed running and low temperature running may result in the oil in the fuel becoming gelled and the piston/liner becoming stuck together.

PRESSURIZED FUEL SYSTEM

It is recommended that a muffler pressurized fuel feed system be used so that the fuel may be stably fed to the carburetor.

The following procedure is suitable when a fuel containing 30% nitro-methane is used.

- Fill the tank completely with fuel.
- Temporarily remove the glowplug to check that it glows bright red when energized.

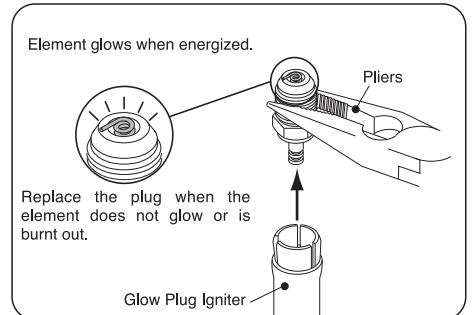

- Turn the needle-valve clockwise slowly until it stops. This is the fully closed position. Do not force to turn further.
- Open the Needle-Valve 2.5 turns from the fully closed position.

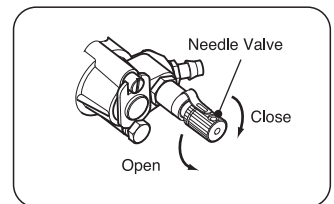

- Switch on the transmitter and make sure that each linkage moves correctly.
- Raise the throttle trim 2 or 3 clicks on the transmitter for easier starting.

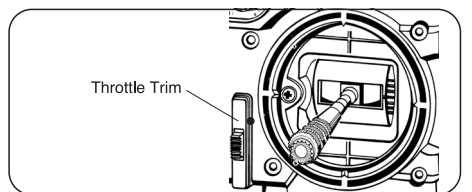

- Turn the engine with an electric starter or recoil starter to draw fuel into the engine.

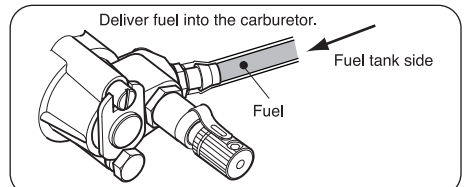

- Now connect glowplug battery lead to heat the plug filament and start the engine.
- Start the engine using an electric starter making sure the engine rotation direction is correct (counter-clockwise seen from the crankshaft end).
- When the engine starts, first repeat low speed running and medium speed running by raising and lowering throttle stick on the transmitter to warm up the engine. Avoid high speed running.

PRECAUTIONS

When starting the engine, with the hull out of the water and no load on the engine, even below half throttle, the engine can over-rev. Prolonged running at higher throttle settings can result in seizure of the connecting rod and crankpin. Never run the engine with the throttle above the starting setting with the hull out of the water and no load on the engine.

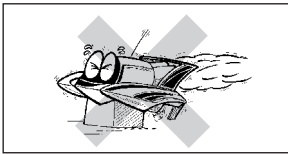

- Next, disconnect the glowplug battery and try running the hull on the water. If the engine stalls, open the throttle fractionally, but try to keep the engine running as rich as possible: if it stops because of being excessively over-rich, close the Needle-Valve 30° and try again.
- Run the hull on the water until one tank of fuel has been consumed, then close the Needle-Valve 10°-15° and run the hull on the water for 1 to 3 full tanks of fuel. Repeat this procedure until approx. 2 liters of fuel have been consumed, during which time the throttle may be opened for brief bursts of increased power. If the engine stops at medium speeds, close the Mixture Control Screw 10°.

The position of the needle-valve when starting the engine.

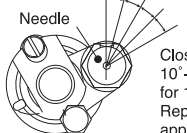

Close the needle-valve approx. 10°-15° after running the hull for 1 tank of fuel. Repeat this procedure until approx. 2 liters of fuel have been consumed.

Remember!

If the engine should need to be disassembled (e.g. for cleaning or minor parts replacement) it is advisable to return the Needle-Valve to the original rich, starting setting and check whether further running-in time is required before the car is raced again. In the event of any major working parts (e.g. piston/cylinder liner assembly) being replaced, the complete running-in should be repeated.

■ TO STOP THE ENGINE

- Lower the throttle trim and/or throttle stick on the transmitter.

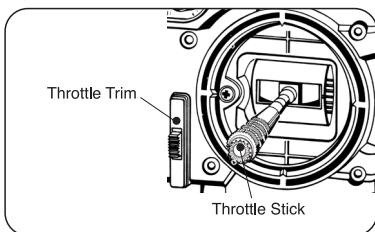

Warning!

Do not touch rotating parts, engine and silencer when stopping the engine as they become very hot, and contact with them may result in a serious burn.

■ FINAL ADJUSTMENT

Final adjustment should be carried out only after the running-in has been completed.

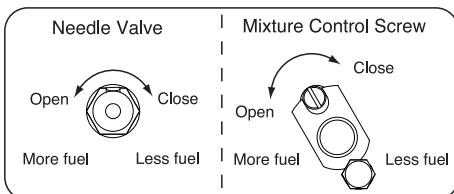

- Run the hull (with throttle fully open) over the longest available straight, in order to observe the model's speed. Next return the hull to the starting point, close the Needle-Valve 10°-15° and repeat the run, taking note of the improvement in performance.
- Continue with further runs, gradually reducing the Needle-Valve setting and aiming to achieve the highest straight-line speed. Remember, however, that, if the Needle-Valve is shut down too far, the engine will overheat and, accompanied by visibly diminished exhaust smoke, the model will lose speed. At this point, throttle down immediately, stop the hull and reopen the Needle-Valve 30°.
- Having established the optimum Needle-Valve setting, check the Mixture Control Valve setting as follows.
- With the engine running, close the throttle and allow it to idle for about five seconds, then reopen the throttle fully. If, at this point, the engine puffs out an excessive amount of smoke and the hull does not accelerate smoothly and rapidly, it is probable that the idle mixture is too rich.
- In this case, turn the Mixture Control Valve clockwise 10°. If, on the other hand, the engine tends to speed up momentarily and then cut out abruptly when the throttle is opened, the idle mixture is too lean. Correct this by turning the Mixture Control Valve counter-clockwise 10°.

NOTE:

Mixture Control Valve adjustment should be made in steps of not more than 10°, carefully checking the effect, on throttle response, of each small adjustment.

- Carry out adjustments patiently, under actual running conditions, until the engine responds quickly and positively to the throttle control.

Warning!

Mixture adjustments (whether via the Mixture Control Valve, or the Needle-Valve) cannot be made accurately under 'no-load' conditions, which, in any case, are not advised, since such operation carries the risk of seriously damaging the engine through over-revving and overheating.

- With the optimum mixture control position, light smoke is visible during high speed running, and the engine rpm increase smoothly during acceleration. Remember that, if the engine is operated with the fuel/air mixture slightly too lean, it will overheat and run unevenly. As with all engines, it is advisable to set both needle-valve and mixture control screw very slightly on the rich side of the best rpm setting, as a safety measure.
- If the engine runs too fast with the throttle closed, the throttle stop screw should be turned counter-clockwise to allow the throttle opening to be reduced.
- Finally, beyond the nominal break-in period, a slight readjustment toward a leaner needle setting may be required to maintain performance.

■ CARE AND MAINTENANCE

1. The minute particles of foreign matter, that are present in any fuel may, by accumulating and partially obstructing fuel flow, cause engine performance to become erratic and unreliable. O.S. 'Super-Filters' (large and small) are available, as optional extras, to deal with this problem. One of these filters installed to the pickup tube inside your refueling container, will prevent the entry of foreign material into the fuel tank. It is also recommended that a good in-line filter be installed between the tank and carburetor.
2. Do not forget to clean the filters regularly to remove foreign matter that accumulate on the filter screens. Also, clean the carburetor itself occasionally.
3. At the end of each operating session, drain out any fuel that may remain in the fuel tank. Afterwards, energize the glow-plug and try to restart the engine, to burn off any fuel that may remain inside the engine. Repeat this procedure until the engine fails to fire. Do this while the engine is still warm.
4. Then, inject some after-run oil into the engine, and rotate the engine with an electric starter for 4 to 5 seconds to distribute the oil to all the working parts.

Note:

Do not inject after-run oil into the carburetor as this may cause the O-rings inside the carburetor to deteriorate. These procedures will reduce the risks of starting difficulties or corrosion after a period of storage.

Note:

Crankshaft of this engine is filled with silicone. Do not use light oil nor kerosene, etc. for washing, or the silicone will swell. Use alcohol or fuel for washing.

5. Finally, when cleaning the exterior of the engine, use methanol or a household cleaning agent. Do not use gasoline, kerosene, or any petroleum based chemical which can damage silicone fuel tubing.

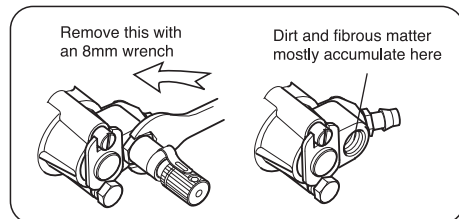

■ CHECKING THE ENGINE

Engine will not develop normal performance after long time running due to wearing of parts. It is suggested to replace necessary parts when the following symptoms are detected.

- Engine sound changes and easily overheats.
- Power has dropped extremely.
- Idling is unstable and/or engine tends to stop at idling.

In most cases, ball bearings, cylinder & piston assembly, connecting rod and/or crankcase have become worn out or abnormal. Check the parts carefully and replace them if necessary.

■ O.S. GENUINE PARTS & ACCESSORIES

- O.S. GLOW PLUG
 - RP6 (71642060)
 - RP7 (71642070)
 - RP8 (71642080)
- LOCK WASHER (10set) M3 (55500002)
- O.S. SPEED PLUG WRENCH (71520100)
- SUPER JOINT TUBE 21 (72106300)
- SUPER FILTER (L) (72403050)
- NON-BUBBLE WEIGHT (S) (71531010)
- REMOTE NEEDLE (23882900)

● O.S. SPEED DRIVER TOOLS

Code No.	Description
71410150	O.S. SPEED HEX WRENCH DRIVER 1.5
71410200	O.S. SPEED HEX WRENCH DRIVER 2.0
71410250	O.S. SPEED HEX WRENCH DRIVER 2.5
71410300	O.S. SPEED HEX WRENCH DRIVER 3.0
71411200	O.S. SPEED HEX BALL WRENCH DRIVER 2.0
71411250	O.S. SPEED HEX BALL WRENCH DRIVER 2.5
71412300	O.S. SPEED FLAT HEAD SCREWDRIVER 3.0
71413550	O.S. SPEED NUT DRIVER 5.5
71413600	O.S. SPEED NUT DRIVER 6.0
71413700	O.S. SPEED NUT DRIVER 7.0

Code No.	Description
71414015	O.S. SPEED HEX WRENCH TIP ONLY 1.5
71414020	O.S. SPEED HEX WRENCH TIP ONLY 2.0
71414025	O.S. SPEED HEX WRENCH TIP ONLY 2.5
71414030	O.S. SPEED HEX WRENCH TIP ONLY 3.0
71414120	O.S. SPEED HEX BALL WRENCH TIP ONLY 2.0
71414125	O.S. SPEED HEX BALL WRENCH TIP ONLY 2.5
71414230	O.S. SPEED FLAT HEAD SCREWDRIVER TIP 3.0
71414355	O.S. SPEED NUT DRIVER TIP ONLY 5.5
71414360	O.S. SPEED NUT DRIVER TIP ONLY 6.0
71414370	O.S. SPEED NUT DRIVER TIP ONLY 7.0

ENGINE EXPLODED VIEW

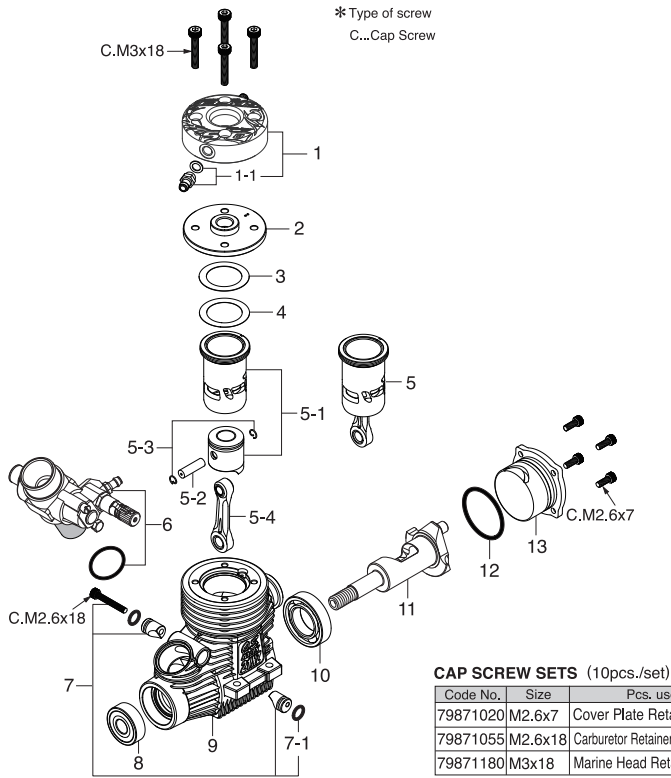

ENGINE PARTS LIST

No.	Code No.	Description
* 1	22014080	Marine Head
1-1	23754721	Nipple No.18
* 2	22014110	Inner Head
3	22014160	Head Gasket Set (0.2mm)
4	22014170	Head Gasket Set (0.1mm)
* 5	22013020	Built-Up Parts Set
* 5-1	22013010	Cylinder & Piston Assembly
* 5-2	22016010	Piston Pin
5-3	21817000	Piston Pin Retainer (2pcs.)
5-4	23755020	Connecting Rod
6	23882000	Carburetor Complete (Type 21D)
7	23981740	Carburetor Retainer Assembly
7-1	24881824	"O" Ring (2pcs.)
8	23731000	Crankshaft Ball Bearing (Front)
* 9	22011020	Crankcase
10	23730020	Crankshaft Ball Bearing (Rear)
* 11	22012080	Crankshaft
12	23764020	Cover Gasket
13	22427000	Cover Plate
	71642070	Glow Plug RP7
	22014160	Head Gasket Set (0.2mm)
	22826140	Exhaust Seal Ring (2pcs.)
	22884250	Dust Cap Set (3mm,16mm, 18mm)

* marked parts are available only for limited period
(one year after finishing the production).

CARBURETOR EXPLODED VIEW

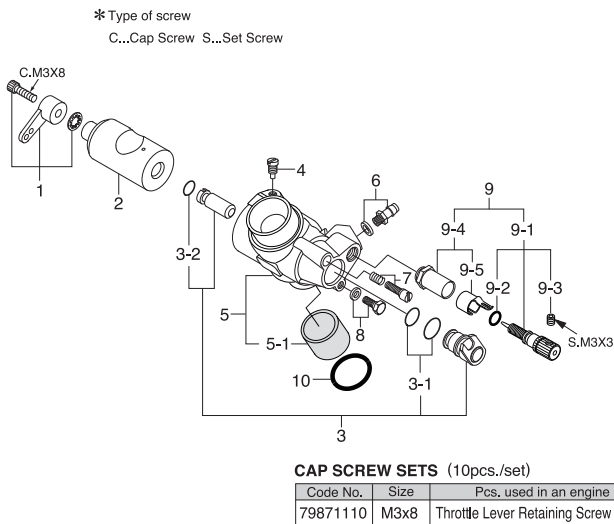

CARBURETOR PARTS LIST

No.	Code No.	Description
1	22081408	Throttle Lever Assembly
2	23882200	Carburetor Rotor
3	23882600	Mixture Control Valve Assembly
3-1	27981850	"O" Ring Set (2pcs.)
3-2	23882630	"O" Ring (S) (2pcs.)
4	45581820	Rotor Guide Screw
5	23882100	Carburetor Body
5-1	23882210	Carburetor Spacer
6	22681953	Fuel Inlet (No.1)
7	27881330	Mixture Control Screw
8	27681340	Mixture Control Valve Stopper
9	25581900	Needle Valve Assembly
9-1	22681980	Needle Assembly
9-2	24981837	"O" Ring (2pcs.)
9-3	26381501	Set Screw
9-4	27381940	Needle Valve Holder Assembly
9-5	26711305	Ratchet Spring
10	29015019	Carburetor Rubber Gasket

THREE VIEW DRAWING

Dimensions (mm)

SPECIFICATIONS

Displacement	3.49 cc / 0.213 cu.in.
Bore	16.27 mm / 0.641 in.
Stroke	16.8 mm / 0.661 in.
Output	2.8 ps / 2.76 hp / 33,000 r.p.m.
Practical R.P.M.	4,000-45,000 r.p.m.
Weight	307.5 g / 10.85 oz. (Engine)

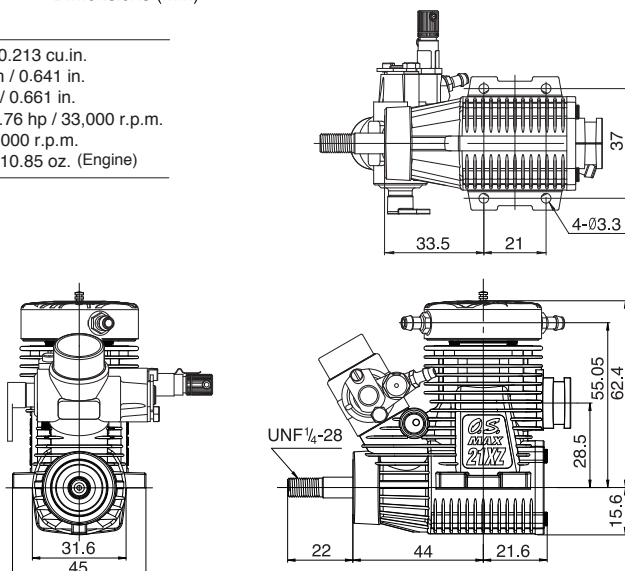

O.S. ENGINES MFG.CO.LTD.

6-15 3-Chome Imagawa Higashiumiyoshi-ku
Osaka 546-0003, Japan TEL. (06)6702-0225
http://www.os-engines.co.jp FAX. (06)6704-2722