

O.S. ENGINE **MAX-18CV-R/18CV-RX**

OWNER'S INSTRUCTION MANUAL

It is of vital importance, before attempting to operate your engine, to read the general **'SAFETY INSTRUCTIONS AND WARNINGS'** section on pages 2-5 of this booklet and to strictly adhere to the advice contained therein.

- Also, please study the entire contents of this instruction manual, so as to familiarize yourself with the controls and other features of the engine.
- Keep these instructions in a safe place so that you may readily refer to them whenever necessary.
- It is suggested that any instructions supplied with the vehicle, radio control equipment, etc., are accessible for checking at the same time.

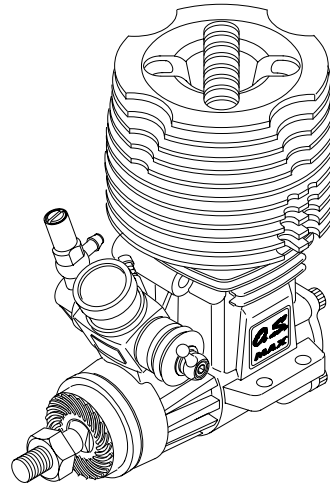

CONTENTS

<p>SAFETY INSTRUCTIONS AND WARNINGS ABOUT YOUR O.S. ENGINE 2-5</p> <p>INTRODUCTION 6</p> <p>BASIC ENGINE PARTS 7</p> <p>INSTALLATION 8-9</p> <p>SUPER AIR CLEANER 203 9-11</p> <p>NOTES CONCERNING THE RECOIL STARTER 11-12</p> <p>GLOWPLUG 12-13</p> <p>TOOLS, ACCESSORIES, etc. 13-14</p> <p>CARBURETOR CONTROLS 15</p> <p>PRESSURIZED FUEL SYSTEM 15</p>	<p>STARTING THE ENGINE & RUNNING-IN ('Breaking-in') 16-17</p> <p>IF THE ENGINE FAILS TO START 18</p> <p>FINAL ADJUSTMENT 18-19</p> <p>CARBURETOR CLEANLINESS 20</p> <p>CARE AND MAINTENANCE 21</p> <p>ENGINES EXPLODED VIEW & PARTS LIST 22-25</p> <p>CARBURETOR EXPLODED VIEW & PARTS LIST 26-27</p> <p>O.S. GENUINE PARTS & ACCESSORIES 28-29</p> <p>THREE VIEW DRAWING 30-31</p> <p>MEMO 32</p>
--	--

SAFETY INSTRUCTIONS AND WARNINGS ABOUT YOUR O.S. ENGINE

Remember that your engine is not a "toy", but a highly efficient internal-combustion machine whose power is capable of harming you, or others, if it is misused.

As owner, you, alone, are responsible for the safe operation of your engine, so act with discretion and care at all times.

If at some future date, your O.S. engine is acquired by another person, we would respectfully request that these instructions are also passed on to its new owner.

■ The advice which follows applies basically to ALL MODEL ENGINES and is grouped under two headings according to the degree of damage or danger which might arise through misuse or neglect.



WARNINGS

These cover events which might involve serious (in extreme circumstances, even fatal) injury.



NOTES

These cover the many other possibilities, generally less obvious sources of danger, but which, under certain circumstances, may also cause damage or injury.



WARNINGS

• Model engine fuel is poisonous. Do not allow it to come into contact with the eyes or mouth. Always store it in a clearly marked container and out of the reach of children.



• Model engine fuel is also highly flammable. Keep it away from open flame, excessive heat, sources of sparks, or anything else which might ignite it. Do not smoke or allow anyone else to smoke, near to it.



• Never operate your engine in an enclosed space. Model engines, like automobile engines, exhaust deadly carbon-monoxide. Run your engine only in an open area.

• Model engines generate considerable heat. Do not touch any part of your engine until it has cooled. Contact with the muffler (silencer), cylinder head or exhaust header pipe, in particular, may result in a serious burn.





NOTES

- This engine is intended for model cars. Do not attempt to use it for any other purpose.
- Mount the engine in your model securely, following the manufacturers' recommendations, using appropriate screws and locknuts.
- Fit an effective silencer (muffler). Frequent close exposure to a noisy exhaust (especially in the case of the more powerful highspeed engines) may eventually impair your hearing and such noise is also likely to cause annoyance to others over a wide area.
- The wearing of safety glasses is also strongly recommended.
- Take care that the glowplug clip or battery leads do not come into contact with rotating parts. Also check that the linkage to the throttle arm is secure.
- For their safety, keep all onlookers (especially small children) well back (at least 20 feet or 6 meters) when preparing your model for running.



NOTES

- To stop the engine, fully retard the throttle stick and trim lever on the trans-mitter, or, in an emergency, cut off the fuel supply by pinching the fuel delivery line from the tank.
- Do not attempt to disassemble the recoil starter of the 18CV-RX. If you do so, the very strong spring inside will be suddenly ejected. This can be very dangerous.
- Do not extend the starter cord more than 45cm (18"). Do not abruptly release the operating handle. Allow the cord to rewind smoothly while still holding the handle.
- Pull the operating handle straight out when starting the engine, so that the cord does not rub against the vehicle body or engine. This will help prevent the cord from being damaged by abrasion or engine heat.
- Warning! Immediately after a glowplug-ignition engine has been run and is still warm, conditions sometimes exist whereby it is just possible for the engine to abruptly restart if it is rotated over compression WITHOUT the glowplug battery being reconnected.

INTRODUCTION

The MAX-18CV-R and MAX-18CV-RX are high-performance engines for 1/10 class R/C cars.

The 18CV-RX is a recoil starter version. Newly developed 11G slide valve carburetor is equipped.

Standard accessories

- Glow Plug No.8
- Super Air Cleaner 203 Assembly
- Engine Mount Spacer (for 18CV-RX)
- Instruction manual

NOTE:

As delivered, the engine has its carburetor lightly fit into its intake. Secure it changing its angle according to the car chassis.

NOTE:

With this engine, the piston will feel tight at the top of its stroke when the engine is cold. This is normal. The piston and cylinder are designed to achieve a perfect running clearance when they reach their normal running temperatures.

About Head Gasket

These engines are fitted with two head gaskets of 0.1mm thick and 0.2mm thick. It is suggested to adjust the total thickness according to atmospheric temperature, humidity and glowplug used.

- At early stage of running-in, when a glowplug tends to burn out early or when high nitromethane content fuel is used, try to run the engine as it is.
- When low nitromethane content fuel is used, try to run the engine removing a 0.1mm gasket.

BASIC ENGINE PARTS

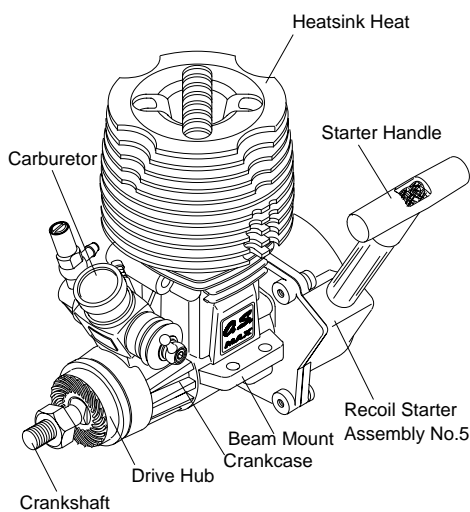

INSTALLING THE GLOWPLUG

Install washer on glowplug and insert carefully into cylinder-head, making sure that it is not cross-threaded before tightening firmly.

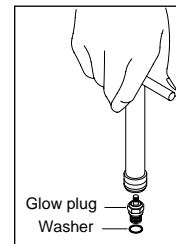

INSTALLATION OF THE CARBURETOR

As delivered, the engine has its carburetor lightly fit into the intake boss. Secure it as follows.

1. Loosen the retainer screw, rotate the carburetor to its correct position and make sure that it is pressed well down into the intake boss, compressing the rubber gasket, before retightening screw.
2. Rotate the retainer screw gently until it stops, then tighten a further 60-90°. Do not overtighten the screw as this will damage the carburetor body.

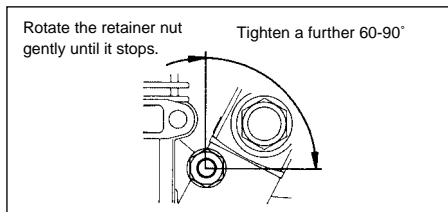

ENGINE INSTALLATION

Make sure that the vehicle's engine mounting surfaces are level and in the same plane. Poor installation may cause distortion of the crankcase, bearings, etc., resulting in erratic running and loss of performance.

The recommended screws for securing the engine are 3mm or 4-40 steel Allen hexagon socket type.

If existing holes in the engine mount do not align perfectly with engine mounting lugs, enlarge them slightly with a needle-file so that screws enter vertically.

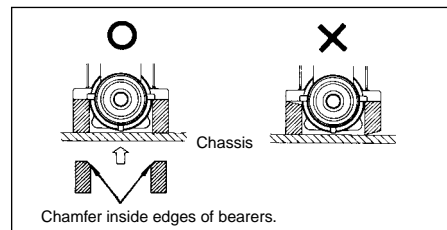

8

Avoid forcing the screws. Secure with locknuts. If the bottom of the recoil starter housing would otherwise touch the car chassis, fit the engine mount spacers (supplied) between the engine's mounting lugs and the engine mount. Use the M3x15 screws provided. With some vehicles, it may be necessary to make minor trimming modifications to chassis or body when fitting the engine.

NOTE:

Where spacers are supplied joined in pairs (see sketch) separate them as shown. Either face may be placed downwards.

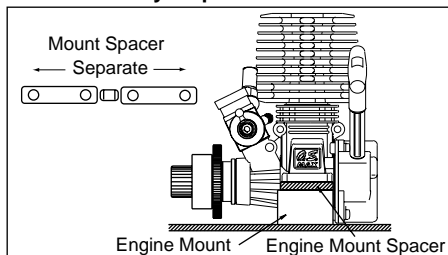

AIR CLEANER TYPE 203

This is a heavy-duty wet type air cleaner that has been developed specifically for 3.5cc 'off-road' model car engines. It is more compact than the former O.S. SUPER AIR CLEANER 202 and this makes it easier to install within a car body.

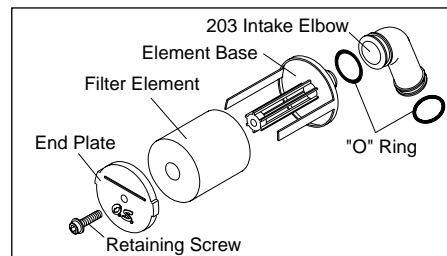

NOTE:

The element is already impregnated with a special filter oil. As this oil is very sticky, take care, when handling it, to prevent dust or dirt from adhering to the element. If your fingers become contaminated, wash them with soap and water.

9

ASSEMBLY

- Insert the filter element on the element base.
- Fit the end plate with retaining screw, making sure that the element fits correctly between the end plate and base.
- Insert the joint pipe on the element base and secure it with "O" ring.
- Fit the end plate, retaining screw, making sure that the element fits correctly between the end plate and base.

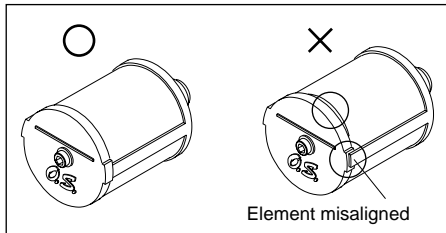

REPLACEMENT OF ELEMENT

NOTE:

During storage, the oil may have become unevenly dispersed through the element. This will be indicated if the blue colour of the element material appears patchy. In this case, place the element in a small plastic bag and gently rub the element between finger and thumb to redistribute oil.

- It is advisable to replace the filter element after each hour of running time. Be careful not to enter the dirt and dust into the carburetor.

INSTALLATION

- Carefully clean the carburettor, removing any old adhesive or sealant that may have been previously used on the outside of the air intake.

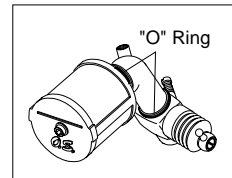

10

FURTHER PRECAUTIONS

When removing the air cleaner, check the inside of the element base and carburetor venturi. If any dirt is detected, this indicates that the filter element was incorrectly fitted or should have been replaced earlier. In this event, it is vitally important to wash out the inside of the engine thoroughly, with alcohol or fuel, before it is used again, otherwise rapid wear of the piston/cylinder assembly, bearings, connecting-rod, etc., will occur. Obviously, it will be necessary to carry out the same procedure with the air cleaner and to replace the filter element.

NOTE:

Be careful not to splash alcohol or fuel over the filter element, or the filter oil will be washed away, and the filter capacity will be lowered.

NOTES CONCERNING THE RECOIL STARTER (18CV-RX ONLY)

REMINDER!

Do not attempt to disassemble the recoil starter. If you do so, the very strong spring inside will be suddenly ejected. This can be very dangerous.

Do not extend the starter cord more than 45cm(18"). Do not abruptly release the operating handle. Allow the cord to rewind smoothly while still holding the handle.

Pull the operating handle straight out when starting the engine, so that the cord does not rub against the vehicle body or engine.

This will help prevent the cord from being damaged by abrasion or engine heat.

Try to avoid spilling fuel over the starter unit and its cord. Some fuels have a detrimental effect on these parts.

- ◆ The starter prevents the engine from being rotated in the wrong direction. The unit will be damaged if you attempt to force the flywheel in the opposite direction (i.e. clockwise when viewed from the crankshaft end).

11

NOTE:

Because, in the interests of personal safety, dismantling of the starter mechanism is strongly discouraged, the Recoil Starter is available for replacement only as a pre-assembled unit. However, some related parts, such as Starting Shaft and Rear Adaptor, are obtainable separately. (See Parts List.)

GLOWPLUG

Since the glowplug and fuel combination used may have a marked effect on performance and reliability, it would be worthwhile to experiment with different plug types. An O.S. No.8 glowplug is supplied with the engine. Other Recommended O.S. plugs are A5 and R5. Carefully install plug finger-tight, before final tightening with the correct size plug wrench.

The role of the glowplug

With a glowplug engine, ignition is initiated by the application of a 1.5-volt power source. When the battery is disconnected, the heat retained within the combustion chamber remains sufficient to keep the plug filament glowing, thereby continuing to keep the engine running. Ignition timing is 'automatic' : under reduced load, allowing higher rpm, the plug becomes hotter and, appropriately, fires the fuel/air charge earlier; conversely, at reduced rpm, the plug become cooler and ignition is retarded.

Glowplug life

Particularly in the case of very high performance engines, glowplugs must be regarded as expendable items.

However, plug life can be extended and engine performance maintained by careful use, i.e.:

- Install a plug suitable for the engine.
- Use fuel containing a moderate percentage of nitromethane unless more is essential for racing events.
- Do not run the engine too lean and do not leave the battery connected while adjusting the needle.

When to replace the glowplug

Apart from when actually burned out, a plug may need to be replaced because it no longer delivers its best performance, such as when:

- Filament surface has roughened and turned white.
- Filament coil has become distorted.
- Foreign matter has adhered to filament or plug body has corroded.
- Engine tends to cut out when idling.
- Starting qualities deteriorate.

TOOLS, ACCESSORIES, etc.

The following items are necessary for operating the engine.

FUEL

Use only top quality methanol-based model engine fuel. For consistent performance and long engine life, it is advisable to use fuel containing AT LEAST 18% lubricant. This engine is designed to run on both low and high nitromethane content fuels, i.e. from mild mixtures containing a few percent of nitromethane, up to high-speed racing fuels containing 40% nitromethane. Generally, power output is increased — up to a certain point — as the nitromethane content of the fuel is increased.

As a starting point, we recommend a fuel containing 10-20% nitromethane, changing to a fuel containing more nitro only if necessary. When the nitro content of the fuel is increased or the brand of fuel is changed, it is advisable to initially run the engine with a richer needle-valve setting, so that the optimum setting for the new fuel may be rechecked as described in the RUNNING-IN paragraphs. When engines are run at very high speeds and on high-nitro fuels, glowplug elements do not last so long.

Reminder!

 Model engine fuel is poisonous. Do not allow it to come into contact with the eyes or mouth. Always store it in a clearly marked container and out of the reach of children.

 Model engine fuel is also highly flammable. Keep it away from open flame, excessive heat, sources of sparks, or anything else which might ignite it.

ELECTRIC STARTER BOX

For starting the engine.
It is not necessary for a recoil starter version-i.e. 18CV-RX.

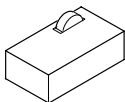

BATTERY INTEGRATED GLOWPLUG HEATER

Commercially available handy glowplug heater in which the glowplug battery and battery leads are integrated.

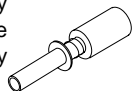

FUEL PUMP

For filling the fuel tank, a simple, polyethylene "squeeze" bottle, with a suitable spout, is required.



LONG SOCKET WRENCH

Recommended for easy removal and replacement of the angled and recessed glowplug, the O.S. Long Socket Wrench incorporates a special grip.

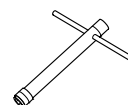

SILICONE FUEL LINE

Heatproof silicone tubing of approx. 5mm o.d. and 2mm i.d. is required for the connection between the fuel tank and engine.

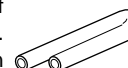

CARBURETOR CONTROLS (11G)

Three adjustable controls are provided on this carburetor.

• The Needle-Valve:

For adjusting the mixture strength when the throttle is fully open.

• The Mixture Control Screw:

For adjusting the mixture strength at part-throttle and idling speeds, to obtain steady idling and smooth acceleration to mid speeds.

• The Throttle Stop Screw:

For setting the minimum idling speed.

NOTE:

Readjustment may be necessary, occasionally to allow for changes in fuel formula, gear ratio or clutch engagement point.

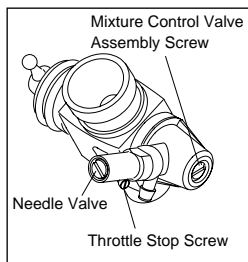

PRESSURIZED FUEL SYSTEM

- The somewhat violent changes of vehicle attitude that occur in off-road running, combined with the fact that, in buggy type cars, the fuel tank is often located some distance from the carburettor, means that fuel 'head' at the carburettor can vary and upset running. Therefore, it is recommended that a muffler pressurized fuel feed system be used.
- Never run your vehicle without installing the air cleaner. Dust and dirt that may otherwise be drawn into the engine will rapidly shorten its life.

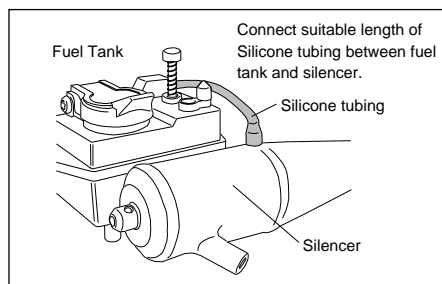

STARTING THE ENGINE & RUNNING-IN ('Breaking-in')

The following procedure is suitable for these engines when the O.S. T-1030 tuned silencer and a fuel containing up to 30% nitromethane are used.

- Use the same fuel as is to be employed for all initial running and containing NOT LESS THAN 18% lubricant.
- Temporarily remove the glowplug to check that it glows bright red when energized.
- Re-check the needle-valve and throttle settings. Turn the needle-valve clockwise slowly and gently until it stops. This is the fully closed position. Do not use force to turn the needle-valve beyond this point.
- Open the Needle-Valve 2 turns from the fully closed position.
- Set the throttle-stop screw so that the minimum throttle opening (idle setting) is approximately 0.3-0.5mm.

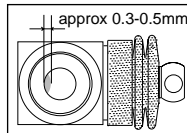
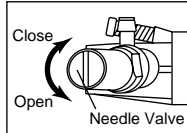

- energize glowplug.
- Start the engine using a starter box, making sure the engine rotation direction is correct (counter-clockwise seen from the crankshaft end). Be sure to fit an air cleaner when starting.

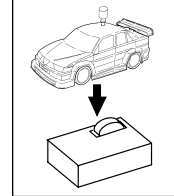

■ In case of the 18CV-RX

- Push the choke button on the fuel tank several times to deliver the fuel to the carburetor. (Do not over-prime or the recoil starter cannot be pulled.)
- Pull the starter handle briskly straight out several times to start the engine.

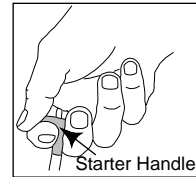

16

Remember!

It is vitally important to set the throttle at the correct position before attempting to start the engine. If the engine is allowed to run with the throttle too far open under "no load" conditions, it will rapidly overheat and may be seriously damaged.

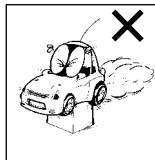

- When the engine starts, first allow it to operate in short runs on its very rich starting settings, with the glowplug battery still connected and with its driving wheels clear of the ground. The rich mixture will, under these conditions, provide adequate lubrication and cooling, indicated by profuse smoke from the exhaust.
- Next, disconnect the glowplug battery and try running the car on the track. If the engine stalls, open the throttle fractionally, but try to keep the engine running as rich as possible: if it stops because of being excessively over-rich, close the Needle-Valve 30° and try again.
- Run the car on the track until one tank of fuel has been consumed, then close the Needle-Valve 30° and run the car for another full tank of fuel. Repeat this procedure until 5 more tanks of fuel have been consumed, during which time the throttle may

be opened for brief bursts of increased power. If the engine stops at medium speeds, close the Mixture Screw 45-90°.

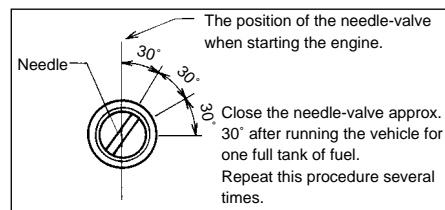

- To stop the engine, close the throttle to idling speed, then shut it off completely with the trim lever on the transmitter. To cut off the fuel supply, pinch the fuel delivery tube to the carburetor.

Remember!

If the engine should need to be disassembled (e.g. for cleaning or minor parts replacement) it is advisable to return the Needle-Valve to the original rich, starting setting and check whether further running-in time is required before the car is raced again. In the event of any major working parts (e.g. piston/cylinder liner assembly) being replaced, the complete running-in should be repeated.

17

IF THE ENGINE FAILS TO START

Check the following:

- Glowplug battery discharged or glowplug defunct.
- Fuel not reaching carburetor.
- Engine flooded. Do not over-prime. (This could also cause hydraulic lock and damage the engine on application of the electric starter.)

Remove glowplug, close needle-valve and apply starter to pump out surplus fuel. At this time cover the plug hole with waste so that splashing fuel will not get into your eyes or mouth.

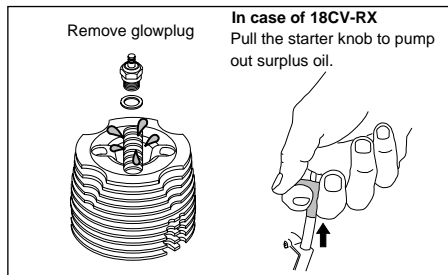

18

FINAL ADJUSTMENT

- Run the vehicle (with throttle fully open) over the longest available straight course, in order to observe the model's speed. Next return the car to the starting point, close the Needle-Valve 30° and repeat the run, taking note of the improvement in performance. Continue with further runs, gradually reducing the Needle-Valve setting and aiming to achieve the highest straight-line speed. Remember, however, that, if the Needle-Valve is shut down too far, the engine will overheat and, accompanied by visibly diminished exhaust smoke, the model will lose speed. At this point, throttle down immediately, stop the vehicle and reopen the Needle-Valve 30°.
- Having established the optimum Needle-Valve setting, check the Mixture Control Valve setting as follows.
- With the engine running, close the throttle and allow it to idle for about five seconds, then reopen the throttle fully. If, at this point, the engine puffs out an excessive amount of smoke and the vehicle does not accelerate smoothly and rapidly, it is probable that the idling mixture is too rich.

- In this case, turn the Mixture Control Valve clockwise 45-90°. If, on the other hand, the engine tends to speed up momentarily and then cut out abruptly when the throttle is opened, the idling mixture is too lean. Correct this by turning the Mixture Control Valve counter-clockwise 45-90°.

NOTE:

Mixture Control Valve adjustment should be made in steps of not more than 45-90°, carefully checking the effect, on throttle response, of each small adjustment.

- Carry out adjustments patiently, under actual running conditions, until the engine responds quickly and positively to the throttle control.

Warning!

Mixture adjustments (whether via the Mixture Control Valve, or the Needle-Valve) cannot be made accurately under 'no-load' conditions, which, in any case, are not advised, since such operation carries the risk of seriously damaging the engine through over-revving and overheating.

- With the optimum mixture control position, light smoke is visible during high speed running, and the engine revolutions increase smoothly during acceleration. Remember that, if the engine is operated with the fuel/air mixture slightly too lean, it will overheat and run unevenly. As with all engines, it is advisable to set both needle-valve and mixture control screw very slightly on the rich side of the best rpm setting, as a safety measure.
- If the engine runs too fast with the throttle closed, the throttle stop screw should be turned counter-clockwise to allow the throttle opening to be reduced.
- Finally, beyond the nominal break-in period, a slight readjustment toward a leaner needle setting may be required to maintain performance.

19

CARBURETTOR CLEANLINESS

The correct functioning of the carburetor depends on its small fuel orifices remaining clear.

■ BALL LINK AND SLIDE VALVE EXTENSION

It is seldom necessary to separate the slide-valve extension from the slide-valve itself. For cleaning, withdraw this complete sub-assembly from the carburetor body after removing the slide-valve guide screw. Then wash with methanol or glow-fuel.

(Note: take care not to lose the guide screw; it is a special one.) When it is necessary to adjust the ball-link position, loosen the ball-link retaining screw with a 3mm hexagon key, re-align the ball-link and re-tighten the screw firmly.

■ REALIGNMENT OF MIXTURE CONTROL VALVE

In the course of making carburetor adjustments, it is just possible that the Mixture Control Valve may be inadvertently screwed in or out too far and thereby moved beyond its effective adjustment range. Its basic position can be found by first rotating the Mixture Control Valve until its slotted head is flush with the carburetor body. The valve is then screwed in exactly 1.5 turns to re-establish its neutral position.

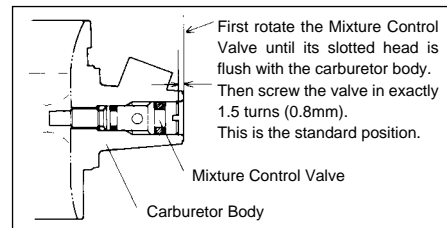

CARE AND MAINTENANCE

1. The minute particles of foreign matter, that are present in any fuel may, by accumulating and partially obstructing fuel flow, cause engine performance to become erratic and unreliable.

O.S. 'Super-Filters' (large and small) are available, as optional extras, to deal with this problem.

One of these filters, fitted to the outlet tube inside your refueling container, will prevent the entry of foreign material into the fuel tank. It is also recommended that a good in-line filter be installed between the tank and carburetor.

2. Do not forget to clean the filters regularly to remove dirt and lint that accumulate on the filter screens. Also, clean the carburetor itself occasionally.

3. At the end of each operating session, drain out any fuel that may remain in the fuel tank. Afterwards, energize the glow-plug and try to restart the engine, to burn off any fuel that may remain inside the engine. Repeat this procedure until the engine fails to fire. Do this while the engine is still warm.

4. Then, inject some after-run oil into the engine, and rotate the engine with an electric starter for 4 to 5 seconds to distribute the oil to all the working parts.

Note:

Do not inject after-run oil into the carburetor as this may cause the O-rings inside the carburetor to deteriorate. These procedures will reduce the risks of starting difficulties or corrosion after a period of storage.

5. Finally, when cleaning the exterior of the engine, use methanol or kerosene. Do not use gasoline or any solvent that might damage the silicone fuel tubing.

Caution:

The rear crankshaft bearing of this engine uses a special plastic retainer. If the front housing needs to be heated to remove or replace the bearing, do not allow the bearing to exceed 120°C (248°F), otherwise it may be damaged and rendered unserviceable.

18CV-R EXPLODED VIEW

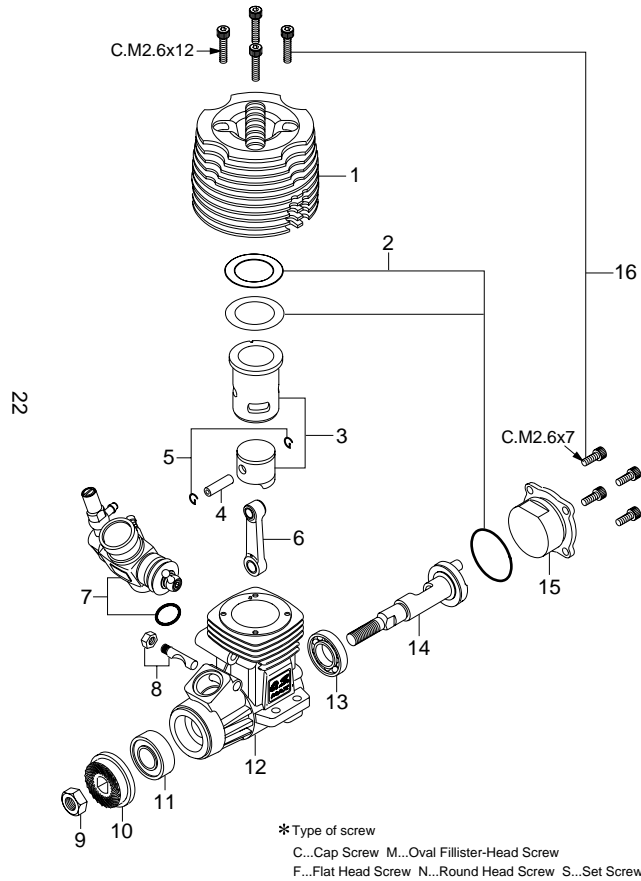

22

18CV-R ENGINE PARTS LIST

No.	Code No.	Description
1	21804000	Heatsink Head
2	21824000	Gasket Set
3	21823000	Cylinder & Piston Assembly
4	21816000	Piston Pin
5	21817000	Piston Pin Retainer (2pcs.)
6	21815000	Connecting Rod
7	21883000	Carburetor Complete (Type 11G)
8	21818000	Carburetor Retainer Assembly
9	20810007	Propeller Nut
10	21408000	Drive Hub
11	21833000	Crankshaft Ball Bearing (Front)
12	21811000	Crankcase
13	21832000	Crankshaft Ball Bearing (Rear)
14	21812000	Crankshaft
15	21807100	Cover Plate
16	21213000	Screw Set
	71608001	Glow Plug No.8
	72413000	Super Air Cleaner 203 Assembly
	72413200	203 Filter Elements (4pcs.)

23

The specifications are subject to alteration for improvement without notice.

18CV-RX EXPLODED VIEW

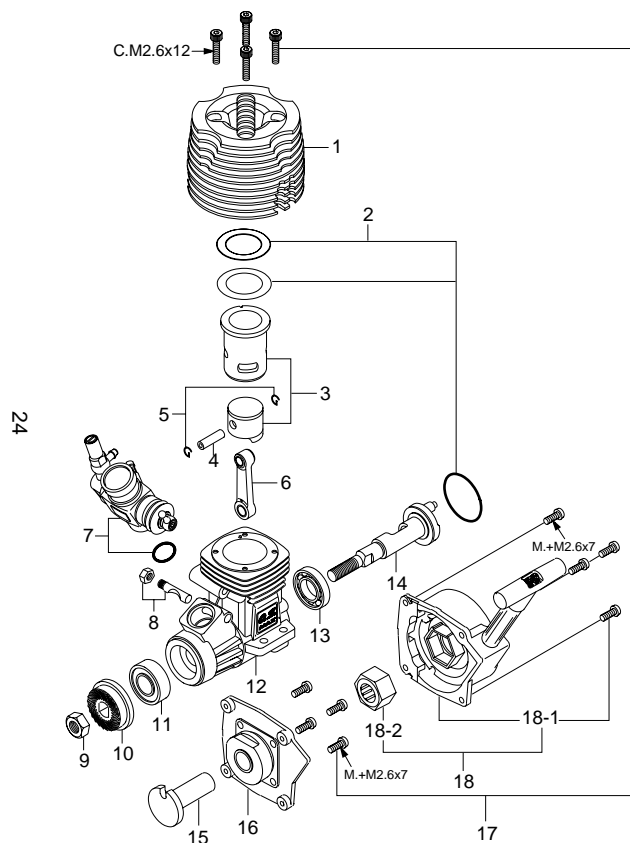

*Type of screw
 C...Cap Screw M...Oval Fillister-Head Screw
 F...Flat Head Screw N...Round Head Screw S...Set Screw

18CV-RX ENGINE PARTS LIST

No.	Code No.	Description
1	21804000	Heatsink Head
2	21824000	Gasket Set
3	21823000	Cylinder & Piston Assembly
4	21816000	Piston Pin
5	21817000	Piston Pin Retainer (2pcs.)
6	21815000	Connecting Rod
7	21883000	Carburetor Complete (Type 11G)
8	21818000	Carburetor Retainer Assembly
9	20810007	Propeller Nut
10	21408000	Drive Hub
11	21833000	Crankshaft Ball Bearing (Front)
12	21811000	Crankcase
13	21832000	Crankshaft Ball Bearing (Rear)
14	21812100	Crankshaft
15	21812200	Starting Shaft
16	21801800	Rear Adaptor
17	21313030	Screw Set
18	73003000	No.5 Recoil Starter Assembly
18-1	73003100	No.5 Recoil Starter Body
18-2	73003200	No.5 One-way Clutch
	71608001	Glow Plug No.8
	72413000	Super Air Cleaner 203 Assembly (W/2 filter elements)
	72413200	203 Filter Elements (4pcs.)
	72404000	Engine Mount Spacer

The specifications are subject to alteration for improvement without notice.

11G CARBURETOR EXPLODED VIEW

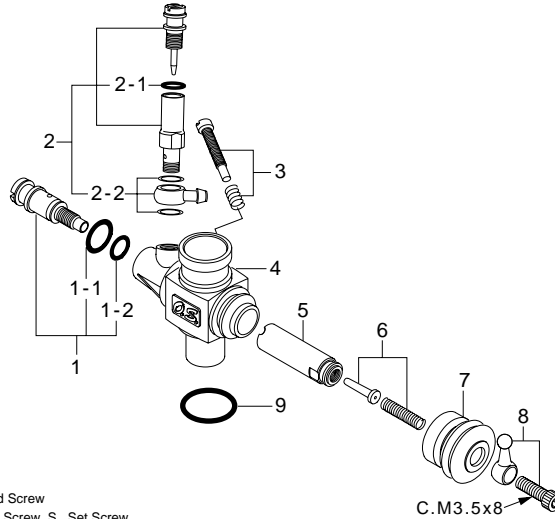

* Type of screw

C...Cap Screw M...Oval Fillister-Head Screw
F...Flat Head Screw N...Round Head Screw S...Set Screw

26

11G CARBURETOR PARTS LIST

No.	Code No.	Description
1	21285600	Mixture Control Valve Assembly
1-1	46066319	"O" Ring(L) (2pcs.)
1-2	22781800	"O" Ring(S) (2pcs.)
2	21285901	Needle Valve Assembly
2-1	27881820	"O" Ring (2pcs.)
2-2	21881950	No.14 Universal Nipple Assembly
3	23818500	Throttle Stop Screw
4	21883100	Carburetor Body
5	21483200	Slide Valve
6	21483600	Metering Needle Assembly
7	21881320	Dust Cover
8	23818420	Ball Link No.4
9	22615000	Carburetor Rubber Gasket

The specifications are subject to alteration for improvement without notice.

27

■ O.S. Glow Plug



A3
(71605300)
A5
(71605100)

■ Exhaust Header Pipes

For Kyosho Super10
(72103110)



For Tamiya TGX
(72103120)



For MUGEN MTX
(72103150)

For Kyosho
V-ONE R,S
(72103160)

For Kyosho Spider & HPI Nitro
(72103140)



For Tamiya TG10
(72103130)



■ Tuned Silencer

T-1030 (72103030)
T-1031 (72103031)
T-1032 (72103032)

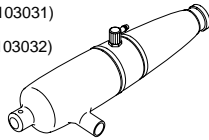

■ SUPER AIR CLEANER 202

(For ON-ROAD CAR) (72412000)

- 202 Cleaner Body (72412100)
- 202 Filter Elements (72412200)

■ Super Joint Tube 15
(72103310)



Dust Cap Set

- ∅3 (5 pcs. set) (73300305)
For Carburetor Nipple
- ∅7 (3 pcs. set) (73300712)
For Tuned Silencer
- ∅16 (3 pcs. set) (73301612)
For Carburetor

■ Cap Screw Set
(10pcs. set)

- M2.6x7 (79871020)
- M2.6x12 (79871040)
- M3.5x8 (79871060)



■ Long Socket Wrench
With Plug Grip
(71521000)

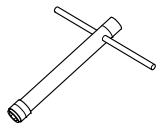

18CV-R THREE VIEW DRAWING

SPECIFICATIONS

■ Displacement	3.0 cc (0.183 cu.in.)
■ Bore	16.0mm (0.629 in.)
■ Stroke	15.0mm (0.590 in.)
■ Practical R.P.M.	3,000-32,000 r.p.m.
■ Power output	1.35 ps / 28,000 r.p.m.
■ Weight	237.5g (8.38oz.)

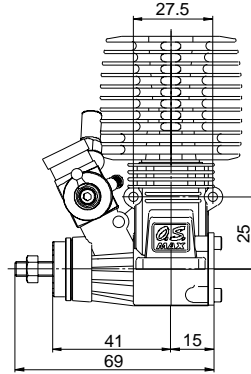
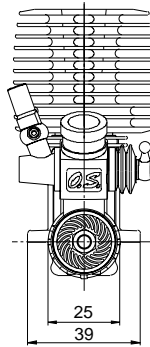
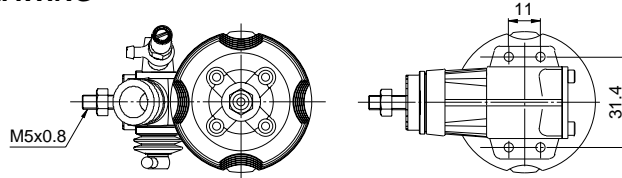

Dimensions(mm)

30

18CV-RX THREE VIEW DRAWING

SPECIFICATIONS

■ Displacement	3.0 cc (0.183 cu.in.)
■ Bore	16.0mm (0.629 in.)
■ Stroke	15.0mm (0.590 in.)
■ Practical R.P.M.	3,000-32,000 r.p.m.
■ Power output	1.35 ps / 28,000 r.p.m.
■ Weight	295.5g (10.43oz.)

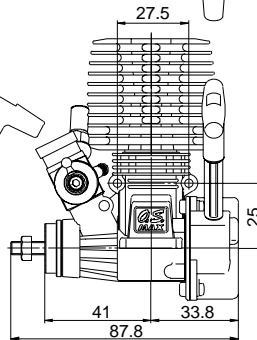
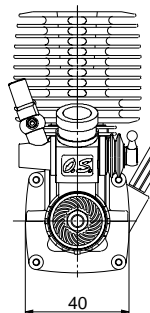
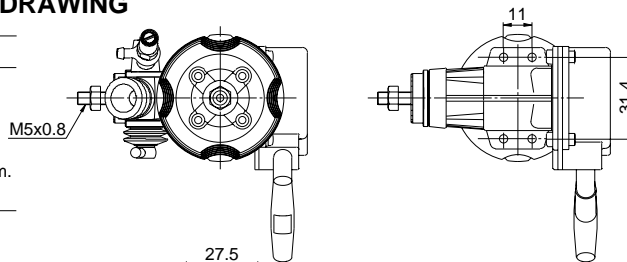

Dimensions(mm)

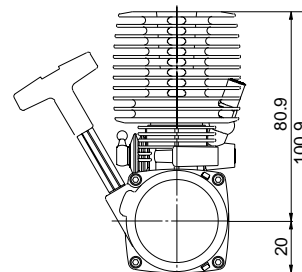

31

MEMO

.....

.....

.....

.....

.....

.....

.....

.....

.....

.....



O.S. ENGINES MFG.CO.,LTD.

6-15 3-Chome Imagawa Higashisumiyoshi-ku

Osaka 546-0003, Japan TEL. (06) 6702-0225

FAX. (06) 6704-2722

URL : <http://www.os-engines.co.jp>