

It is of vital importance, before attempting to operate your engine, to read the general 'SAFETY INSTRUCTIONS AND WARNINGS' section below and to strictly adhere to the advice contained therein.

Also, please study the entire contents of this instruction sheet, so as to familiarize yourself with the controls and other features of the engine.

Keep these instructions in a safe place so that you may readily refer to them whenever necessary.

It is suggested that any instructions supplied with the boat, radio-control equipment, etc., are accessible for checking at the same time.



The position of the nipples on the head of the engine here is different from the picture and exploded view shown in the instruction manual. However, it has nothing to do with its performance. Please operate it as it is.

CONTENTS

SPECIFICATIONS, SAFETY INSTRUCTIONS AND WARNINGS ABOUT YOUR O.S. ENGINE. _____	1
INSTALLATION, CARBURETTOR, RECOIL STARTER, etc. _____	2
RUNNING-IN, CARBURETTOR ADJUSTMENT. _____	3
CARE AND MAINTENANCE, EXPLODED VIEW, PARTS LISTS. _____	4

SPECIFICATIONS

Displacement 2.49cc (0.152cu.in.)	Practical R.P.M. 3,000~ 25,000 r.p.m.
Bore 15.2mm (0.598 in.)	Power output ... 0.6bhp / 22,000 r.p.m.
Stroke 13.7mm (0.539 in.)	Weight 167g (5.89 oz.) (15CV-M) 225g (7.94 oz.) (15CV-MX)

SAFETY INSTRUCTIONS AND WARNINGS ABOUT YOUR O.S. ENGINE

Remember that your engine is not a "toy", but a highly efficient internal-combustion machine whose power is capable of harming you, or others, if it is misused or abused.

As owner, you, alone, are responsible for the safe operation of your engine, so act with discretion and care at all times.





If at some future date, your O.S. engine is acquired by another person, we would respectfully request that these instructions are also passed on to its new owner.

■ The advice which follows is grouped under two headings according to the degree of damage or danger which might arise through misuse or neglect.

! WARNINGS Cover events which might involve serious (in extreme circumstance, even fatal) injury.

! NOTES Cover the many other possibilities, generally less obvious sources of danger, but which, under certain circumstances, may also cause damage or injury.

! WARNINGS

- Never touch, or allow any object to come into contact with, the rotating propeller and do not crouch over the engine when it is running. 
- Model engine fuel is poisonous. Do not allow it to come into contact with the eyes or mouth. Always store it in a clearly marked container and out of the reach of children. 
- Model engine fuel is also highly flammable. Keep it away from naked flame, excessive heat, sources of sparks, or anything else which might ignite it. Do not smoke or allow anyone else to smoke, near to it. 
- Never operate your engine in an enclosed space. Model engines, like automobile engines, exhaust deadly carbon-monoxide. Run your engine only in an open area.
- Model engines generate considerable heat. Do not touch any part of your engine until it has cooled. Contact with the muffler (silencer), cylinder head or exhaust header pipe, in particular, may result in a serious burn. 

! NOTES

- This engine was designed for model boats. Do not attempt to use it for any other purpose.
- Mount the engine in your model securely, following the manufacturers' recommendations, using appropriate screws and lock-nuts.
- Fit an effective silencer(muffler). Frequent close exposure to a noisy exhaust (especially in the case of the most powerful high-speed engines) may eventually impair your hearing and such noise is also likely to cause annoyance to others over a wide area.
- For their safety, keep all onlookers (especially small children) well back (at least 12 feet or 4 metres) when preparing your model for running.
- Take care that the glowplug clip or battery leads do not come into contact with the propeller or any other rotating parts. Also check the linkage to the throttle arm.
- If your engine does not have a built-in recoil starter, use an electric starter. The wearing of safety glasses is also strongly recommended.
- When handling the boat immediately prior to launching, be especially cautious. Keep the propeller and other rotating parts away from you.
- Adjust the throttle linkage so that the engine stops when the throttle stick and trim lever on the transmitter are fully retarded. Alternatively, the engine may be stopped by cutting off the fuel supply. Never try to stop the engine physically.
- Warning! Immediately after a glowplug-ignition engine has been run and is still warm, conditions sometimes exist whereby it is just possible for the engine to fire if the glowplug battery is accidentally reconnected.
- If your engine is fitted with a recoil starter, pull the operating handle straight out when starting the engine, so that the cord does not rub against the hull or engine. This will help prevent the cord from being damaged by abrasion or engine heat.
- Do not extend the starter cord more than 45cm (18"). Do not abruptly release the operating handle. Allow the cord to rewind smoothly while still holding the handle.
- Do not attempt to disassemble the recoil starter. If you do so, the very strong spring inside will be suddenly ejected. This can be very dangerous.

The O.S.'CV Series' is a high-performance water-cooled marine engine designed for small radio-controlled boats, especially sport type hulls. A companion model, the MAX-15CV-MX incorporating a recoil starter system, is also available.

NOTE

- With this engine, the piston will feel tight at the top of its stroke when the engine is cold. This is normal. The piston and cylinder are designed to achieve a perfect running clearance when they reach their normal running temperatures.
- We do not recommend running your boat on the sea, or in any other saltwater environment. Under such conditions, it is difficult to prevent the engine from becoming corroded and, eventually, inoperative.

FITTING THE GLOWPLUG

Fit washer to glowplug and insert carefully into cylinder-head, making sure that it is not cross-threaded before tightening firmly.

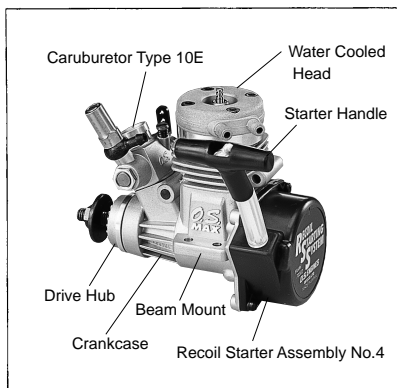

INSTALLATION OF THE CARBURETTOR

As delivered, the engine has its carburettor lightly fitted into its intake boss. Secure it as follows.

Loosen the nut of the retainer and rotate the carburettor to its correct position. Make sure that the carburettor is pressed well down into the intake boss, compressing the rubber gasket, before retightening the nut. Rotate the nut gently until it stops, then tighten it a further 60-90°. Do not over tighten as this may damage the carburettor body. (See sketch, below right)

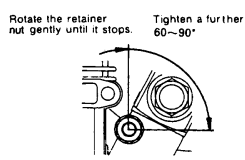

INSTALLATION

1. Make sure that the engine-bed mounting beams in the hull are parallel, with their top surfaces in the same plane. If they are not, the engine will not rest firmly as the engine mounting faces (undersides of the mounting lugs) are precision machined to be flat and in the same plane. Poor installation may not only cause vibration, erratic running and loss of performance, but may also damage the engine itself by deforming the crankcase, cylinder, etc.
2. The mounting beams and adjacent hull structure should be as rigid as possible so that the engine may develop its full performance. Use 3mm steel screws, such as Allen socket-head type, with locknuts, for bolting the engine to the mounting beams.
3. If the holes in the mounting beams do not align exactly with the engine's mounting lugs, enlarge them slightly with a needle file so that the fixing screws pass through the holes smoothly without being forced.

NOTES CONCERNING THE RECOIL STARTER (MAX-15CV-MX ONLY)

REMINDER:

- ◆ Do not attempt to disassemble the recoil starter. If you do so, the very strong spring inside will be suddenly ejected. This can be very dangerous.
- ◆ Do not extend the starter cord more than 45cm (18"). Do not abruptly release the operating handle. Allow the cord to rewind smoothly while still holding the handle.
- ◆ Pull the operating handle straight out when starting the engine, so that the cord does not rub against the vehicle body or engine. This will help prevent the cord from being damaged by abrasion or engine heat.
- ◆ Try to avoid spilling fuel over the starter unit and its cord. Some fuels have a detrimental effect on these parts.
- ◆ The starter prevents the engine from being rotated in the wrong direction. The unit will be damaged if you attempt to force the flywheel in the opposite direction (i.e. clockwise when viewed from the crankshaft end).

Note:

Because, in the interests of personal safety, dismantling of the starter mechanism is strongly discouraged, the Recoil Starter is available for replacement only as a pre-assembled unit. However, some related parts, such as the Starting Shaft and Rear Adaptor, are obtainable separately. (See Parts List.)

FUEL

Use only top quality model two-stroke engine fuel. For consistent performance and long engine life, it is advisable to use fuel containing AT LEAST 18% lubricant. This engine is designed to run on both low and high nitromethane content fuels, i.e. from mild mixtures containing a few percent of nitromethane, up to high-speed racing fuels containing 40%, or more, of nitromethane. Generally, power output is increased up to a certain point - as the nitromethane content of the fuel is increased. As a starting point, we recommend a fuel containing 10-20% nitromethane, changing to a fuel containing more nitro if necessary. When the nitro

content of the fuel is increased or the brand of fuel is changed, it is advisable to initially run the engine with a richer needle-valve setting, so that the optimum setting for the new fuel may be rechecked as described in the RUNNING-IN paragraphs. When engines are run at very high speeds and on high-nitro fuels, glowplug elements do not last so long.

REMINDER:

- ▲ Model engine fuel is poisonous. Do not allow it to come into contact with the eyes or mouth. Always store it in a clearly marked container and out of the reach of children.
- ▲ Model engine fuel is also highly flammable. Keep it away from naked flame, excessive heat, sources of sparks, or anything else which might ignite it. Do not smoke or allow anyone else to smoke, near to it.

GLOWPLUG

The O.S. A3 glowplug is recommended and one is supplied with this engine. The MAX-15CV-M & 15CV-MX may not always run so well with other types of plug.

The role of the glowplug

With a glowplug engine, ignition is initiated by the application of a 1.5-volt power source. When the battery is disconnected, the heat retained within the combustion chamber remains sufficient to keep the plug filament glowing, thereby continuing to keep the engine running. Ignition timing is 'automatic': under reduced load, allowing higher rpm, the plug becomes hotter and, appropriately, fires the fuel/air charge earlier; conversely, at reduced rpm, the plug becomes cooler and ignition is retarded.

Glowplug life -

Particularly in the case of very high performance engines, glowplugs must be regarded as expendable items. However, plug life can be extended and engine performance maintained by careful use, i.e.:

- Fit a plug suitable for the engine (e.g. OS A3).
- Use fuel containing a moderate percentage of nitromethane unless essential for racing events.
- Do not run the engine too lean and do not leave the battery connected while adjusting the needle.

When to replace the glowplug -

Apart from when actually burned out, a plug may need to be replaced because it no longer delivers its best performance, such as when:

- Filament surface has roughened and turned white.
- Filament coil has become distorted.
- Foreign matter has adhered to filament or plug body has corroded.
- Engine tends to cut out when idling.
- Starting qualities deteriorate.

GLOWPLUG BATTERY

The power source for heating the glowplug may be either a large, heavy-duty 1.5-volt dry cell, or a 2-volt rechargeable lead-acid cell with extended leads (or a resistance) to reduce the applied voltage to approximately 1.5-v.

BATTERY LEADS

These are used to conduct current from the battery to the glowplug. For convenience, special leads with a suitable clip to fit the glowplug terminal, are commercially available.

LONG SOCKET WRENCH

Recommended for easy removal and replacement of the deeply recessed glowplug, the O.S. Long Socket Wrench incorporates a special grip. (See Parts List)

FUEL BOTTLE OR PUMP

For filling the fuel tank, a simple, polyethylene "squeeze" bottle, with a suitable spout, is required. Alternatively, one of the purpose-made manual or electric fuel pumps may be used to transfer fuel directly from your fuel container to the fuel tank.

FUEL CAN FILTER

Fit a filter to the outlet tube of your refuelling container to prevent entry of foreign matter into the fuel tank. O.S. 'Super-Filters' (large and small) are available as optional extras.

SILICONE TUBING

This is required for the piping between the fuel tank and engine.

ELECTRIC STARTER AND STARTER BATTERY

Use an electric starter with 12-volt battery for starting the MAX-15CV.

PROPELLER

Use well balanced propellers only. As the ideal diameter, pitch and shape vary according to the size, weight and type of model, final selection can be made after practical experiment. As a starting point, suggested propeller diameter is 34-36mm with a pitch/dia ratio of 1.0-1.2 for Vee type hulls.

- ▲ Never touch, or allow any object to come into contact with, the rotating propeller and do not crouch over the engine when it is running.

BEFORE STARTING THE ENGINE

- The rapid changes of hull attitude that occur when a fast boat is operating in choppy water, especially when the fuel tank is located at some distance from the carburettor, means that fuel "head" at the carburettor jet can vary quite considerably, causing the engine to run erratically or stop. Therefore, it is advisable to use a moderately pressurized fuel system.
- Check the glowplug. If the plug element is distorted, off-center, or has a white appearance, engine performance may be below par. Replace the plug if necessary.
- When re-starting the engine, turn the flywheel by hand, as before (but without removing the glowplug) to make sure that there is nothing unusual, before energizing the glowplug and applying the starter.

WARNING:

Never attempt to turn the engine with the starter if the engine is over-primed with fuel or flooded with corrosion-inhibiting oil. To do so is likely to seriously damage the working parts.

ADJUSTING THE CARBURETTOR

Three adjustable controls are provided on this carburettor. (See photo below.)

- **The Needle-Valve:**
For adjusting the mixture strength when the throttle is fully open.
- **The Mixture Control Screw:**
For adjusting the mixture strength at part-throttle and idling speeds, to obtain steady idling and smooth acceleration to mid speeds.
- **The Throttle Stop Screw:**
For setting the position where the carburettor rotor is closed.

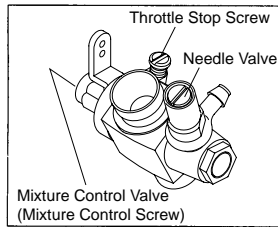

Adjust the throttle linkage so that the throttle can be fully closed to stop the engine prior to lifting the boat from the water. (If necessary, consult your R/C system handbook for setting up linkage in relation to transmitter stick movement.)

Note:

In the course of making adjustments, it is just possible that the mixture control screw may be inadvertently screwed in or out too far and its original position lost. In this case, reset the controls as follows:

First, remove the air cleaner. Then unscrew the throttle stop screw until the throttle opening is just closed completely. At this point, screw in the mixture control screw slowly clockwise until it stops. (Do not use force, otherwise the screw tip will damage the jet hole on the opposite side.) Now unscrew the mixture control screw one complete turn. Finally, turn the throttle stop screw slowly clockwise until the throttle rotor is opened approximately 0.5mm as shown.

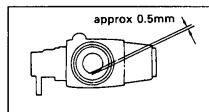

BEFORE STARTING THE ENGINE

REMINDER:

With this engine, the piston will feel tight at the top of its stroke when the engine is cold. This is normal. The piston and cylinder are designed to achieve a perfect running clearance when they reach their normal running temperatures.

- ◆ Use the same fuel as is to be used for all initial running (i.e. containing 10% nitromethane.)
- ◆ Open the Needle-Valve 3 turns from the fully closed position. See sketch, right.
- ◆ Set the throttle very slightly opened (approx. 15°) from the idling position.

Attention!

It is vitally important to set the throttle at the correct position before starting the engine. If the engine is allowed to run with the throttle too far open under "no load" conditions (i.e. with the driving wheels not in contact with the ground) it will rapidly overheat and may be seriously damaged.

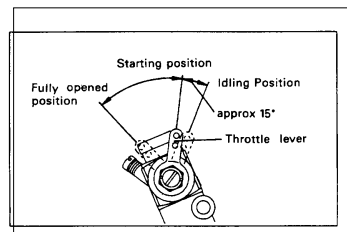
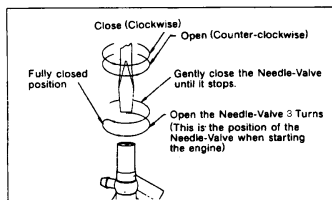

WARNING:

Do not apply the starter to a flooded engine and never place your finger over the carburettor intake when using the starter. This may cause an hydraulic lock and bend the connecting-rod.

- Adjusting the needle-valve: adjust the needle-valve to its optimum setting only while actually running your boat on the water.
- To stop the engine, fully close the throttle to cut off air supply.

RUNNING-IN ('Breaking-in')

For long life and high-performance, every engine needs to be properly 'run-in' or 'broken-in'. There are several running-in methods, but the following is suitable for use with this engine.

- ◆ Re-check the needle-valve and throttle settings. Turn the needle-valve clockwise slowly and gently until it stops. This is the fully closed position. Do not use force to turn the needle-valve beyond this point. Now reopen the needle-valve 3 turns. Set the throttle at the starting position and start the engine.
- ◆ Leaving the needle-valve at the starting setting of 2. turns open, run the boat on the track with the throttle open. If the engine stops, due to being over-rich, close the needle-valve 20° to 30° and try again. It should be remembered that, at this stage, response to the throttle control will be less than perfect, due to the rich setting (indicated by dense exhaust smoke) that is required for initial running-in.
- ◆ Run the car on the track with this needle setting until one full tank of fuel has been consumed. Now close the needle-valve approximately 30° and run the vehicle for another full tank of fuel. Repeat this procedure, gradually closing the needle-valve, between runs, until the highest speed is obtained. (See diagram below). Make a note of the needle-valve setting at this point. By this time, the exhaust smoke will have thinned to a light grey colour.

- ◆ If the needle-valve is closed beyond this high-speed setting, the boat will slow down, accompanied by visibly diminished exhaust smoke. In this case bring the vehicle to a halt immediately and reopen the needle-valve 20° to 30°.

- ◆ Now open the needle-valve 20° to 30° from the setting at which the highest straight-line speed can be obtained. This is the optimum needle-valve setting. Run the boat for about three tanks of fuel with this optimum setting.

- ◆ The completion of the above procedure marks the conclusion of the running-in period, although, as further running time is recorded, a slight readjustment towards a leaner setting may be required to maintain maximum performance. If the engine should need to be disassembled (e.g. for cleaning or minor parts replacement) it is advisable to return the needle-valve to the original rich, starting setting and check whether further running-in time is required before the boat is raced again. In the event of any major working parts (e.g. piston/cylinderliner assembly) being replaced, the complete running-in process should be repeated.

Note:

Having established the optimum needle-valve setting, make a note of the number of turns necessary to re-establish this from the closed position.

- ◆ After the optimum needle-valve setting has been determined, the mixture control screw should be checked as follows:
Close the throttle and allow the engine to idle for about five seconds, then open the throttle fully. If, at this point, the engine puffs out a good deal of smoke and does not accelerate smoothly and rapidly, it is probable that the idling mixture is too rich. In this case, turn the mixture control screw clockwise 45° to 90°. If, on the other hand, the engine tends to speed up momentarily and then cut out abruptly when the throttle is opened, the idling mixture is too lean. In this case, turn the mixture control screw counter-clockwise 45° to 90°.

Note:

Mixture control screw adjustment should be made in increments of 45° to 90°, checking the effect on the throttle response of each small adjustment.

- ◆ Carry out adjustments patiently under actual running conditions, until the engine responds quickly and positively to the throttle control.

Note: Reminder!

Mixture adjustment cannot be made accurately under 'no load' conditions which, in any case, are not advised since such running carries a risk of damaging the engine through over-revving.

- ◆ With the optimum mixture control screw position, light smoke is visible during high speed running, and the engine revolutions increase smoothly during acceleration.
Remember that, if the engine is operated with the fuel/air mixture slightly too lean, it will overheat and run unevenly. As with all engines, it is advisable to set both needle-valve and mixture control screw very slightly on the rich side of the best rpm setting, as a safety measure.
- ◆ If the engine runs too fast with the throttle closed, the throttle stop screw should be turned counter-clockwise to allow the throttle opening to be reduced.

ADJUSTMENT

WARNING :

Running the engine with the boat out of the water, without load and without cooling water, will seriously damage it, due to overheating. Therefore, always lower the boat into the water immediately after the engine has been started, so as to prevent over-speeding and to allow cooling water to be forced up to the cylinder-head. Having carried out the initial running-in ("breaking-in") procedure as described before, complete the running-in as follows:

- 1) Open the throttle slightly from the idling position and start the engine, following the procedure described previously.
- 2) Lower the boat into the water, gradually open the throttle and run the boat straight ahead for 20 to 30 metres at full throttle. Now return the model and close the needle-valve 20 to 30°. Repeat the run, taking note of the improvement in speed.
- 3) Continue with further runs, gradually closing the needle-valve (20 to 30° at a time) until no further increase in speed is obtained.
- 4) If the needle-valve is closed beyond the optimum setting, the model will slow down, accompanied by visibly diminished exhaust smoke. In this case, immediately throttle down and return the model to shore. Re-open the needle-valve approximately one-half turn and repeat the runs until the optimum needle setting is found.
- 5) Aim to have the model achieving its highest performance after the engine has consumed about one litre of fuel. Having found the optimum needle-valve setting, make a note of the number of turns necessary to re-establish this from the closed position.
- 6) With the engine run-in and the optimum needle-valve setting determined, the mixture control valve should be checked as follows:
- 7) Launch the boat and gradually open the throttle to its fullest extent. If at this point, the engine puffs out a good deal of smoke and does not accelerate smoothly and rapidly, it is a sign that the idling mixture is too rich.
Therefore, turn the mixture control screw clockwise 45 to 60°. Repeat the run and recheck the result.
- 8) If, on the other hand, the idling mixture is too lean, the engine is likely to speed up momentarily, then cut out abruptly when the throttle is re-opened.
In this case, first turn the mixture control screw counter-clockwise 90° to make sure that the mixture has become richer, then make incremental adjustments, each way, until an acceptable balance between rich v. lean settings is achieved.
Carry out these adjustments patiently under actual running conditions, until the engine responds quickly and positively to throttle movements. Use a small screwdriver to adjust the mixture control valve via its slotted screwhead in the centre of the outer end of the throttle rotor.

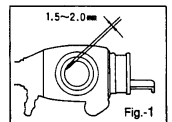
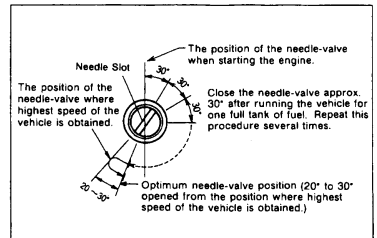

- 9) With the optimum mixture control valve position, light smoke is visible during high-speed running and engine revolutions increase smoothly during acceleration.
Remember that, if the engine is operated with the fuel / air mixture slightly too lean, it will overheat and run unevenly or cut out. As with all engines, it is wise to set both valves a little on the rich side of the best rpm setting, as a safety measure.
- 10) When the best balance of mixture adjustments has been determined and, especially as the engine becomes fully run-in, it will probably be found that the idling speed has increased.
Readjust the throttle opening by means of the trim lever on the transmitter, so that the lowest idling speed, without risk of stalling the engine, may be obtained.

CARBURETTOR CLEANLINESS

The correct functioning of the carburettor depends on its small fuel orifices remaining clear. The minute particles of foreign matter that are present in any fuel, can easily partially obstruct these orifices and upset mixture strength so that engine performance becomes erratic and unreliable.

O.S. 'Super-Filters' (large and small) are available, as optional extras, to deal with this problem. One of these filters, fitted to the outlet tube inside your refueling container, will prevent the entry of foreign material into the fuel tank. It is also recommended that a good in-line filter be installed between the tank and carburettor.

Do not forget to clean the filters regularly to remove dirt and lint that accumulate on the filter screens. Also clean the carburettor itself occasionally.

CARE AND MAINTENANCE

To ensure that you obtain long life and peak performance from your engine, observe the follow-ing.

- ① As previously observed, foreign matter in the fuel can cause problems. Therefore:
- rinse out the fuel tank with methanol or fuel before installing it.
 - fit a fuel filter to the fuel delivery tube between tank and carburettor.
 - fit a fuel filter to the outlet of your squeeze bottle, or to the pump inlet if you use a manual or electric pump. *
 - do not leave your fuel container open needlessly.
- * O.S. 'Super-Filters' (large and small) are available, as optional extras, to deal with this problem.
One of these filters, fitted to the outlet tube inside your refuelling container, will prevent the entry of foreign material into the fuel tank.
- ② Do not forget to clean the filters regularly to remove dirt and lint that accumulate on the filter screens. Also, clean the carburettor itself occasionally.
- ③ At the end of each operating session, drain out any fuel that may remain in the fuel tank.
Afterwards, energize the glowplug and try to restart the engine, to burn off any fuel that may remain inside the engine.
Repeat this procedure until the engine fails to fire. Leaving fuel residues within the engine can result in difficult starting after a period of storage. It may also cause corrosion. To reduce such risks, it is helpful to inject some corrosion inhibiting oil into the engine's air intake.
Rotate the engine many times to distribute the oil to all the working parts.

- ④ Drain the water remaining in the water cooling head, and wash out with methanol, then inject corrosion-inhibiting or moisture-displacing oil.
- ⑤ When cleaning the exterior of the engine, use methanol or kerosene. Do not use gasoline or any solvent that might damage the silicone fuel tubing or any plastic parts of the boat hull.
- ⑥ When the engine is not in use remove the glowplug and rinse out the interior with kerosene (not gasoline), by rotating the crankshaft. Shake out residue, then inject light machine-oil through the plug hole again rotating the shaft to distribute the protective oil to all working parts.

TROUBLE SHOOTING WHEN THE ENGINE FAILS TO START

Four key points

For quick, reliable starting, the following four conditions are required.

- ① Good compression. ② Adequate "glow" at glowplug. ③ Correct mixture. ④ Sufficient electric starter rotating speed.

If the engine fails to start, or does not keep running after being started, check symptoms against the following chart and take necessary corrective action. Note: The most common causes of trouble are marked with three asterisks, the less common problems with one or two asterisks.

Symptom	Factor	Cause	Corrective action
Engine fails to fire.	① *	Sluggish rotation	Recharge the electric starter battery.
	**	Glowplug battery	Recharge lead-acid cell or replace dry battery. (Note: An unused, or almost unused, dry battery may sometimes be of insufficient capacity if it is "old stock".)
	*	Glowplug element is	Replace glowplug. Check that applied voltage is not too high.
Engine fires intermittently but does not run.	*	Something wrong with	Check glowplug heating using other leads.
	**	Engine "flooded"	Close needle-valve fully and remove glowplug. Apply starter to pump out excess fuel. Re-start engine.
	② *	Insufficient fuel	Repeat priming procedure.
Engine fires once or twice, then fails to fire.	**	Incorrect heating of	Voltage too high or too low. Re-check and readjust referring to "BEFORE STARTING".
	**	Excess fuel	Continue to apply starter. If necessary disconnect battery from glowplug and leave for a few minutes, then re-energize plug. If engine still does not start, remove glowplug and pump out excess fuel. Then re-start.
Engine starts but revolutions decrease and engine eventually stops.	*	Sluggish rotation	Recharge the electric starter battery.
	**	Glowplug battery	Recharge lead-acid cell or replace dry battery. (Note: An unused, or almost unused, dry battery may sometimes be of insufficient capacity if it is "old stock".)
Engine starts, then revolutions increase and engine cuts out.	**	Insufficient fuel	Repeat priming procedure.
	***	Mixture too rich	Close needle-valve half turn (180°) and wait for several minutes, then re-start.
Engine stops when battery leads are disconnected after starting.	*	Fuel not reaching the	Make sure that tank is filled with fuel. Check that there is not something wrong with fuel tubing (kinked or split). Check that carburettor is not clogged with dirt.
	**	Mixture too rich	Close the needle-valve a little.
	*	Mismatch of glow plug	Change fuel or glowplug, and fuel.

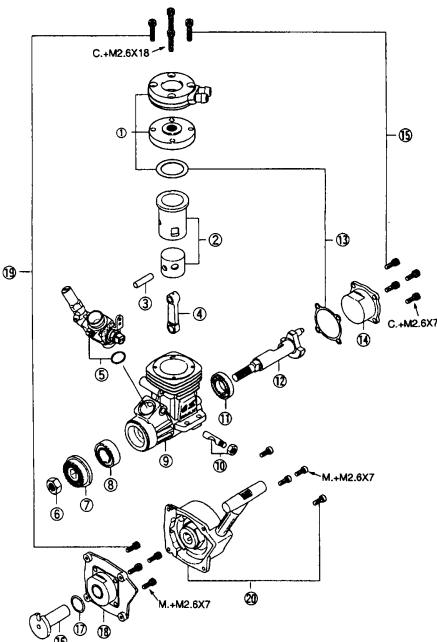

ENGINE PARTS LIST

No.	Code No.	Description
①	21240010	Water Cooled Head Assembly
②	21503000	Cylinder & Piston Assembly
③	21706000	Piston Pin
④	21205040	Connecting Rod
⑤	21481000	Carburettor Complete(10E)
⑥	20810007	Propeller Nut
⑦	21408000	Drive Hub
⑧	22631019	Crankshaft Ball Bearing(Front)
⑨	21501020	Crankcase
⑩	21481700	Carburettor Retainer
⑪	21230000	Crankshaft Ball Bearing(Rear)
⑫	21202010	Crankshaft
	21202000	
⑬	21214020	Gasket Set
⑭	21407030	Cover Plate
⑮	21213030	Screw Set
⑯	21421200	Starting Shaft
⑰	21221500	Rear Thrust Washer
⑱	21421300	Rear Adaptor
⑲	21213020	Screw Set
⑳	73002000	No.4 Recoil Starter Assembly
	71605300	Glow Plug A3
*	21225000	871 Silencer
*	72110000	881 Universal Silencer
*	71801040	Flywheel No.1D
*	21342000	Universal Joint Assembly
*	71530100	Crankshaft Clamp 1012
*	71521000	Long Socket Wrench

* Optional extra parts

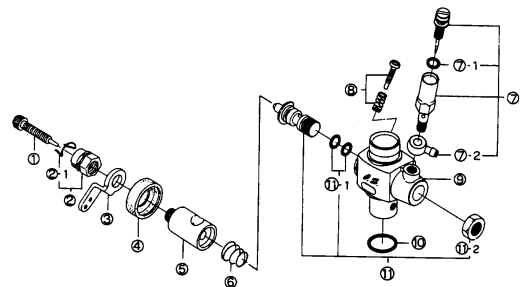

CARBURETTOR PARTS LIST

No.	Code No.	Description
①	22481628	Mixture Control Screw
②	22481420	Throttle Lever Fixing Nut
②-1	22481449	Idle Ratchet
③	22681419	Throttle Lever
④	21283210	Dust Cover
⑤	21481200	Carburettor Rotor
⑥	22481506	Rotor Spring
⑦	21481900	Needle Valve Assembly
⑦-1	27881820	"O" Ring (2pcs.)
⑦-2	21481950	Universal Nipple No.12
⑧	22681310	Throttle Stop Screw (w/Spring)
⑨	21481100	Carburettor Body
⑩	22615000	Carburettor Gasket
⑪	21283962	Nozzle Assembly
⑪-1	24881824	"O" Ring (2pcs.)
⑪-2	21283961	Locknut

* Type of screw C---Cap Screw M---Oval Filister-Head Screw F---Flat Head Screw N---Round Head Screw S---Set Screw

O.S. ENGINES MFG. CO., LTD.

6-15 3-Chome Imagawa Higashiumiyoshi-ku

Osaka 546-0003, Japan TEL. (06)702-0225

FAX. (06)704-2722